

Regensammler mit Grobfilter

- (GB) Water butt filler with filter
- (F) Collecteur de l'eau de pluie avec filtre à grande maille
- (NL) regencollector met grove filter
- (S) Regnsamlare med galler
- (I) Coletor de água pluvial com filtro grosso

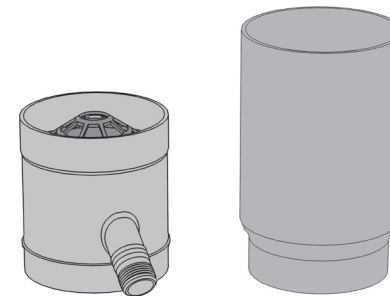

2000305
2000300

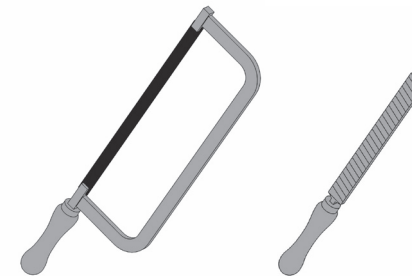

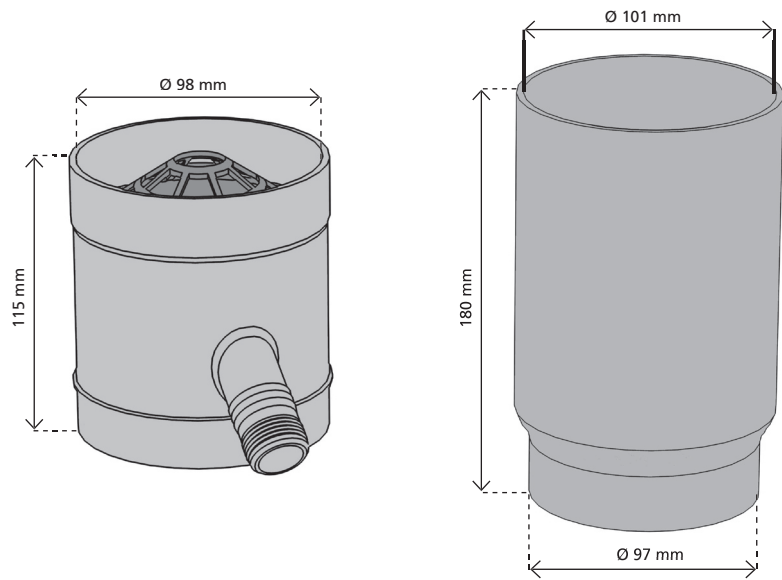

1.

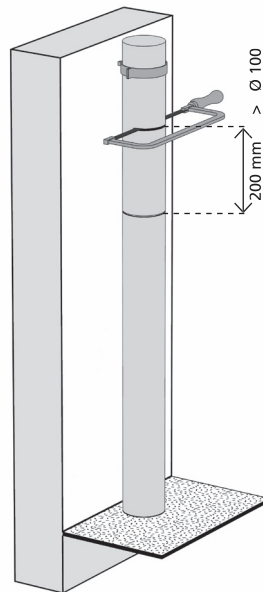

2.

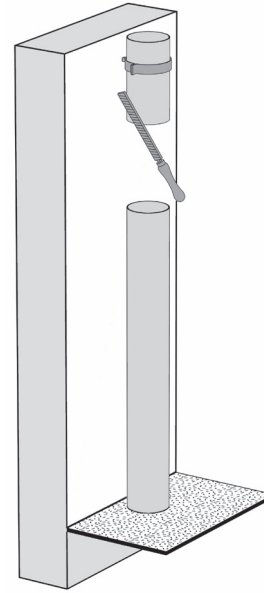

3.

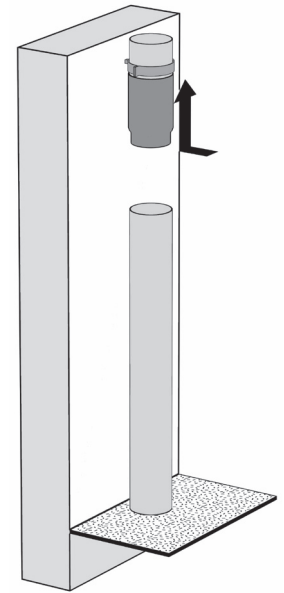

4.

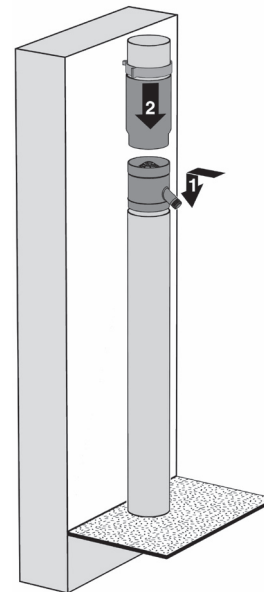

5.

